



SHEET METAL WORKING MACHINES  
**Thin sheet metal sector**

# Sheet metal folders for thin sheet metal applications up to 4 mm

PowerBend Professional



PowerBend Universal



Graphic control POS 2000 Professional



PowerBend Multi



MAKU



Software control Classic Bend

Better sheet metal working – we have dedicated ourselves to enabling highest quality standards and efficient processes in the production of sheet metal products. This brochure can only give you an initial overview of our machines designed for thin sheet metal applications up to 4 mm steel sheet – we are pleased to offer you our advice to selecting a suitable machine for your requirements.

## More than 70 years of sheet metal working

Since more than 70 years Hans Schröder Maschinenbau GmbH specialized in the development of modern machine concepts for bending and cutting sheet metal for craftsmen and for industrial production processes. The family owned company founded in 1949 by Hans Schröder unifies traditional and modern approaches in machine building: technical competence and high commitment to innovation, intensive quality- and service orientation, the work for and with the customer as well as a trusting cooperation with suppliers and employees.

Graphic control POS 3000



Segmented tools

Working length	2,000	2,500	3,200	4,000
Sheet thickness (400 N/mm <sup>2</sup> )				
Folding machines				
1.50			MAKU	
2.00		MAKU	PBM	PBM
2.50	MAKU	PBM		PBP/PBU
3.00			PBP/PBU	
4.00	PBU			

## Table of content

### Folding machines, motorized

▪ PowerBend Professional	4   5
▪ PowerBend Universal	8   9
▪ PowerBend Multi	12   13
▪ MAKU	16   17
▪ Software control	20   21
▪ Tools	24   25

# Folding machine PowerBend Professional

The PowerBend Professional is our revised folding machine with even more flexible application possibilities. It is the perfect solution for thin sheet metal processing and continuous use in large workshops, medium-sized businesses and industry.



PowerBend Professional

Work. length x Sheet thckn. (400 N/mm<sup>2</sup>) 3,240 x 3.0 mm 4,040 x 2.5 mm



The rotating clamping beam offers a second set of tools and an alternative machine geometry. (New: Clamping beam directly driven with servo motors)

Folding beam lowering with servo drive and recirculating ball screws

The PowerBend platform is based on decades of experience in industrial folding machines. It was engineered using state of the art tools, and finite element analysis. The resulting rigid frame provides a base from which the PowerBend achieves unmatched speed, precision, and operational efficiency. Thanks to the superior drive technology and advanced electronic control, the PowerBend Professional can handle complex geometries and difficult bending requirements with ease.

At the same time the machine offers the flexibility your company needs for the production of short runs and prototypes. With the hydraulic tool clamping device and the optional rotating clamping beam, set up times can be drastically reduced. The result is a considerable increase in productivity.

## Highlights

- Clamping beam stroke 540 mm for product heights up to 250 mm
- 2 servo drives for continuous commuting of the Up-and-Down folding beam
- Servo-controlled folding beam adjustment
- More precise and faster positioning of the folding center, servo-controlled
- Safety package Plus
- LED status display
- Energy-efficient drives according to IE3
- Optimized for industry 4.0
- Prepared interface to product handling systems





Standard equipment	
Software control	<ul style="list-style-type: none"> <li>– POS 2000 Professional control on swivelling arm</li> <li>– Radius function</li> <li>– Remote maintenance</li> </ul>
Clamping beam	<ul style="list-style-type: none"> <li>– Clamping beam stroke: 540 mm</li> <li>– Clamping beam geometry: 48° or optional 180°</li> <li>– Drive: 2 x 2.2 kW; 65 mm/s, axis with recirculated ball screws</li> <li>– Axis inclination of clamping beam</li> <li>– Hydraulic tool clamping device (WZS 2000)</li> </ul>
Folding beam	<ul style="list-style-type: none"> <li>– Drive: 2 x 3.0 kW (converter controlled, 100°/sec)</li> <li>– Motorized folding beam adjustment: 150 mm with servo drive and recirculated ball screws (converter controlled)</li> <li>– Motorized folding center adjustment: +80/-20 mm (converter controlled)</li> <li>– Motorized central crowning device</li> <li>– Pneumatic tool clamping device (WZS 15100)</li> </ul>
Bottom beam	<ul style="list-style-type: none"> <li>– Bottom beam blade, ca. 1100 N/mm<sup>2</sup> surface-hardened (nitrated), one-piece with finger grooves, minimum gauge 10 mm (WZS 16300)</li> </ul>
Back gauge	<ul style="list-style-type: none"> <li>– Motorized back gauge up to 1,600 mm (closed; 2 sectors with pneumatic lowering device, sheet support table with balls; recirculated ball screws ± 0,1 mm)</li> </ul>
Others	<ul style="list-style-type: none"> <li>– Standard machine without folding- and clamping beam tools</li> <li>– Foot switch, anchor plates incl. dowels, LED Status display</li> </ul>

Special equipment	
Clamping beam	<ul style="list-style-type: none"> <li>– Rotating clamping beam (48°/180°) for 2 tool stations incl. hydraulic tool clamping device on both sides (WZS 2000)</li> </ul>
Technology package Up-and-Down	<ul style="list-style-type: none"> <li>– Up' n Down folding beam program-controlled: 2 servo drives for continuous commuting of the folding beam</li> <li>– Operation from the front and the rear</li> <li>– When operating from the front: only up-bends possible</li> <li>– External programming</li> <li>– Up and Down bottom beam blade, one-piece, ca. 1100 N/mm<sup>2</sup>; 30°, R 1/1,5/3 with finger grooves, minimal gauge 10 mm (WZS 16300)</li> <li>– U-gauge up to 1600 mm (2 sectors, balls in table)</li> <li>– Access security in front via light barriers</li> <li>– 2nd foot switch on rail for lateral movement</li> <li>– Servo-controlled folding center adjustment</li> </ul>
Technology package 3D (only with Up-and-Down):	<ul style="list-style-type: none"> <li>– POS 3000 3D Graphic control: DXF-Import and more processor capacity</li> <li>– Suction plates in gauge table with 6 suction units, program-controlled incl. positioning against the folding beam</li> <li>– 2 fixed square arms (left + right side)</li> <li>– 2 pneumatic pop up square arms assembled aisle side, program-controlled</li> </ul>
Table and back gauge	<ul style="list-style-type: none"> <li>– Back gauge extension to J- or U-gauge. Basis: motorized gauge up to 1600 mm, closed (see p. 7)</li> <li>– 2 fixed square arms (left + right side)</li> <li>– 2 pneumatic pop up square arms assembled aisle side, program-controlled</li> </ul>
Safety	<ul style="list-style-type: none"> <li>– Additional equipment for 2-man-operation in accordance with accident prevention rules</li> <li>– Additional operation from the rear 2nd footswitch + access security in front via light barriers</li> <li>– Customized light barrier package in front, horizontal light curtain aisle side RFID switch thru cabinet door</li> </ul>
Others	<ul style="list-style-type: none"> <li>– Foot switch on rail for lateral movement</li> <li>– Voltage transformer 12 kVA and air conditioner</li> <li>– Options for software control see p. 20f and tool options see p. 24–25</li> </ul>



# Dimensions and technical data

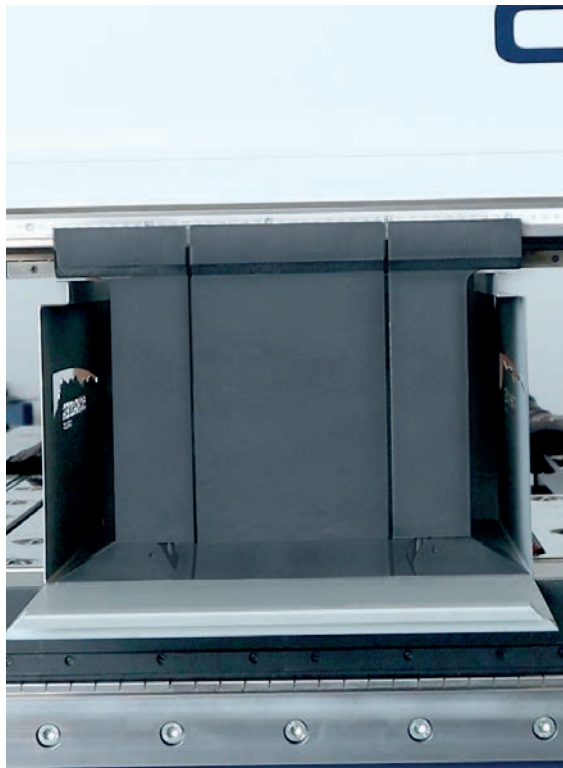

PowerBend Professional	3,200 x 3.0	4,000 x 2.5
Working length (a)	3,240 mm	4,040 mm
Sheet thickness 400 N/mm <sup>2</sup>	3.0 mm	2.5 mm
Machine length (b)	5,700 mm	6,500 mm
Machine height with swivelling arm	2,313 mm	2,313 mm
Machine width with back gauge (c)		
1 600 mm closed table	3,223 mm	3,223 mm
U-1600	3,223 mm	3,223 mm
U or rather J-3200	4,955 mm	-
U or rather J-4000	-	5,743 mm
Weight basic machine (ca.)	7,800 kg	8,700 kg
Weight incl. rotating clampin beam (ca.)	9,200 kg	10,100 kg
Clamping beam		
Geometry	48° (180°)	48° (180°)
Stroke	540 mm	540 mm
Drive power	2 x 2.2 kW	2 x 2.2 kW
Speed	65 mm/s	65 mm/s
Folding beam		
Drive power	2 x 3.0 kW	2 x 3.0 kW
Speed	100 °/s	100 °/s
Folding beam adjustment, motorized	150 mm	150 mm
Folding center adjustment, motorized	+80/-20 mm	+80/-20 mm

Hydraulic too clamping and clamping beam stroke of 540 mm for up to 250 mm high products.

All specifications are considered as guidelines and may be subject to changes at any time.

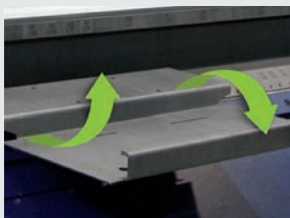

## Up-and-Down folding beam

You will love this option: The Up-and-Down folding beam allows counterfolds in one work step, e.g. boxes with Z-bend. Instead of folding only from the bottom up, here the folding beam hits the workpiece from above. Folding from two directions eliminates the need to turn the sheet. Particularly with larger formats, this means fewer helping hands, less muscle power, and fewer risks for the material surfaces. In short: more ergonomics, safety and productivity.

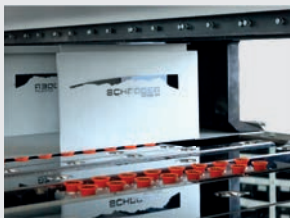

## Suctions cups in the back gauge table controlled via POS 3000

The PowerBend Professional is the only machine in its class that also offers pneumatic fixing of sheets as additional completion of the back gauge: The suction plates in the back auge grip where gauge fingers cannot find a reliable hold, for example because the workpiece has recesses or curves on the stop side. The sheet is suctioned once and, thanks to the intelligent control, all bends on one side run automatically at the push of a button without further handling by the machine operator.

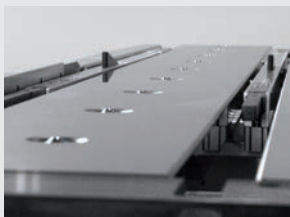

## Exact positioning of sheets

In the basic version, the PowerBend Professional offers a sheet support table that allows gauging from 10 to 1,600 mm. The optional fixed angle gauges on the left and right are suitable for folding long, thin sheets at exactly the right angle. For these gauge options, we also offer pneumatically lowerable angle gauges aisle side. In addition, it is possible to extend the back gauge table to a J- or U-shaped table. The basis here is the 1 600 mm back gauge (see p. 7). The high-quality recirculating ball screws achieve a dimensional accuracy of  $\pm 0.1$  mm. An extremely helpful function is also the option to gauge against the folding beam, which allows you to measure the side of the workpiece to be bent.

### Dimensions: PowerBend Professional

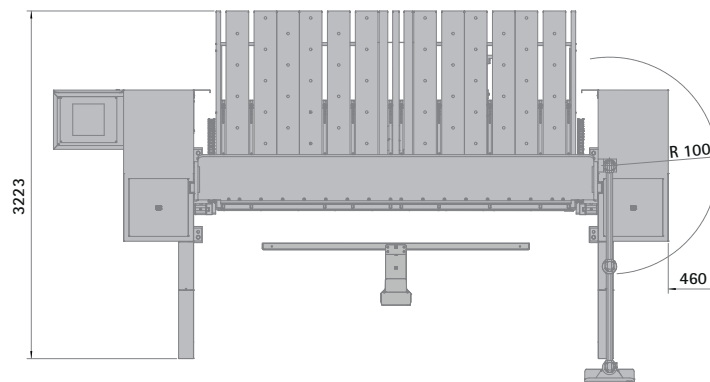
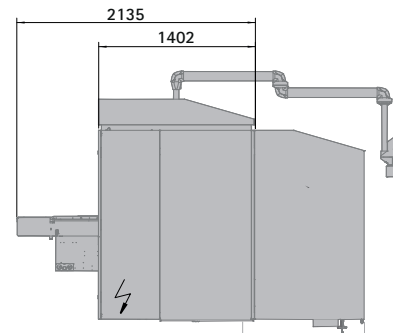
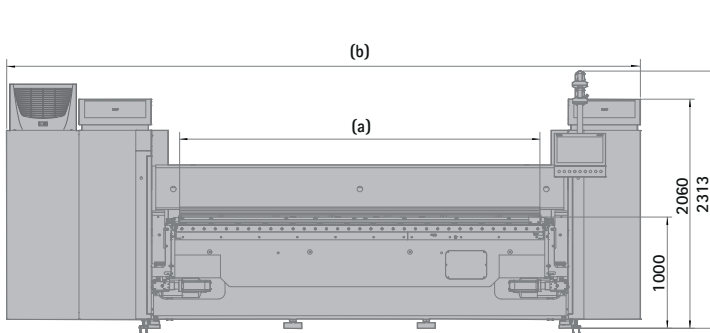

Finger distance for work. length 3240 mm

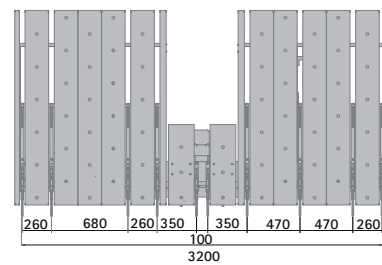

### Options for back gauge extensions

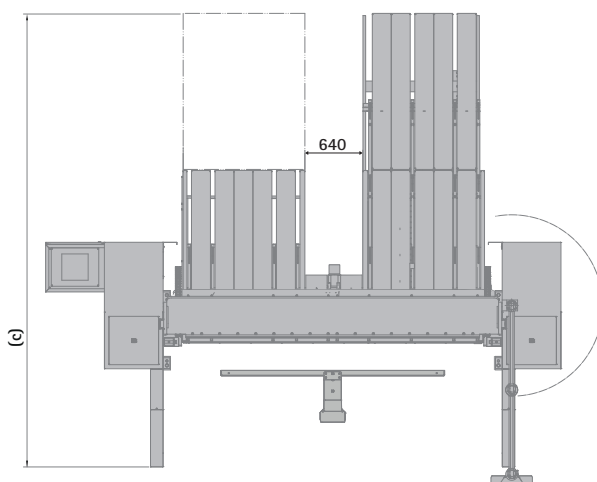

J-shape 3,200/1,600, 4 x 800 mm  
 J-shape 4,000/1,600, 5 x 800 mm

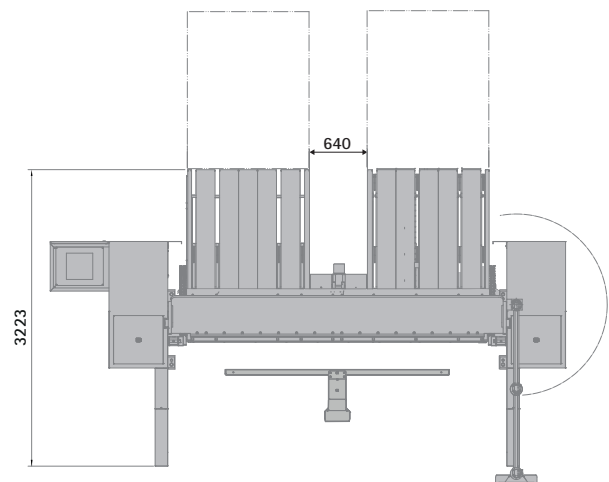

U-shape 1,600, 2 x 800 mm  
 U-shape 3,200, 4 x 800 mm  
 U-shape 4,000, 5 x 800 mm

# Folding machine PowerBend Universal

The versatile solution for lean sheet metal forming in a wide variety of metal forming applications.



PowerBend Universal			
Work. length x Sheet thickn. (400 N/mm <sup>2</sup> )	2,040 x 4.0 mm	3,240 x 3.0 mm	4,040 x 2.5 mm



Segmented tools provide flexibility for a variety of geometries.

The name says it all: the folding machine PowerBend Universal has been constructed to meet the demands for a wide range of applications. In order to create a machine for all application areas up to 4 mm sheet thickness, Hans Schröder Maschinenbau took advantage of decades of experience in industrial sheet metal working.

The PowerBend Universal provides the perfect balance between technology and performance. It offers the greatest precision, longevity and an extremely rigid machine body that has been engineered using state of the art tools and finite element analysis.

The path-breaking electronic software control including the radius-step-bending function in standard, can be programmed quickly and easily with no computer skills. Anyone can program with the new software Classic Bend, making it the perfect machine for a wide array of production requirements. This software increases production and efficiency without increased complexity.



Classic Bend control on swivelling arm: a modern, alphanumeric control system





Standard equipment	
Software control	<ul style="list-style-type: none"> <li>– Positioning control Classic Bend, touchscreen monitor on swivelling arm</li> <li>– Radius function</li> </ul>
Clamping beam	<ul style="list-style-type: none"> <li>– Drive: 2 x 2.2 kW (converter controlled, 65 mm/sec, recirculated ball screws)</li> <li>– Clamping beam stroke: 350 mm (325 mm with manual clamping device)</li> <li>– Clamping beam geometry: 48° or optional 180°</li> <li>– Manual tool clamping device (WZS 020)</li> </ul>
Folding beam	<ul style="list-style-type: none"> <li>– Drive: 2 x 2.2 kW (converter controlled, 85°/sec)</li> <li>– Manual folding beam adjustment: 80 mm</li> <li>– Manual tool clamping device (WZS 15000/15100)</li> </ul>
Bottom beam	<ul style="list-style-type: none"> <li>– Bottom beam blade, one-piece, ca. 1100 N/mm<sup>2</sup> surface-hardened (nitrated) minimum gauge 10 mm</li> </ul>
Back gauge	<ul style="list-style-type: none"> <li>– Motorized back gauge up to 1,000 mm, pneumatic pop up gauge fingers, sheet support table with balls, recirculated ball screws (<math>\pm 0,1</math> mm)</li> </ul>
Others	<ul style="list-style-type: none"> <li>– Standard machine without folding- and clamping beam tools</li> <li>– Foot switch, anchor plates incl. dowels</li> </ul>

Special equipment	
Software control	<ul style="list-style-type: none"> <li>– Technology package POS 2000 Professional: graphic control with touchscreen on swivelling arm, motorized folding beam adjustment 80 mm, remote maintenance</li> <li>– POS 2000 Professional PC Version (external programming)</li> </ul>
Clamping beam	<ul style="list-style-type: none"> <li>– Hydraulic tool clamping device (WZS 2000)</li> </ul>
Folding beam	<ul style="list-style-type: none"> <li>– Power-Package folding beam (only for working length 3,200 mm): increases the bending capacity by 1 mm: reinforced drive incl. folding blade 35 mm, ca. 1100 N/mm<sup>2</sup> (in combination with sharp-nose blade WZS 020, bending angle restriction to max. 140°)</li> <li>– Pneumatic tool clamping device (only in combination with WZS 15100)</li> <li>– Motorized folding beam adjustment: 80 mm</li> <li>– Manual central crowning device</li> <li>– Motorized central crowning device (Requirement: Technology package POS 2000 Professional)</li> </ul>
Table and back gauge	<ul style="list-style-type: none"> <li>– Motorized back gauge up to 1,600 mm (closed; 2 sectors with pneumatic lowering device, sheet support table with balls; recirculated ball screws <math>\pm 0,1</math> mm)</li> <li>– Back gauge extension to J- or U-gauge. Basis: motorized gauge up to 1600 mm, closed (see p. 11)</li> <li>– 2 fixed square arms (left + right side)</li> <li>– 2 pneumatic pop up square arms assembled aisle side (only in connection with POS 2000 Professional)</li> </ul>
Safety	<ul style="list-style-type: none"> <li>– Additional equipment for 2-man-operation in accordance with accident prevention rules</li> <li>– Additional operation from the rear 2nd footswitch + access security in front via light barriers</li> </ul>
Others	<ul style="list-style-type: none"> <li>– Foot switch on rail for lateral movement</li> <li>– Voltage transformer and air conditioner</li> <li>– Options for software control see p. 20f and tool options see p. 24-25</li> </ul>

# Dimensions and technical data



PowerBend Universal	2,000 × 4.0	3,200 × 3.0	4,000 × 2.5
Working length (a)	2,040 mm	3,240 mm	4,040 mm
Sheet thickness (400 N/mm <sup>2</sup> )	4.0 mm	3.0 mm	2.5 mm
Machine length (b)	3,970 mm	5,170 mm	5,970 mm
Machine height	1,553 mm		
Working height	1,000 mm		
Machine height with swivelling arm	2,163 mm		
Weight basic machine (ca.)	5,800 kg	7,100 kg	8,080 kg
Machine width with back gauge (c)			
1 000 mm closed table	3,097 mm		
1 600 mm closed table	3,097 mm		
U-1600 mm	3,097 mm		
U or rather J-3200 mm	-	4,829 mm	-
U or rather J-4000 mm	-	-	5,617 mm
Clamping beam			
Geometry	48° (180°)		
Stroke	350 mm (325 mm with manual clamping device)		
Drive power	2 × 2.2 kW		
Speed	65 mm/sec		
Folding beam			
Drive	2 × 2.2 kW		
Speed	(85°/sec)		
Folding beam adjustment, manual/motorized	80 mm		

Standard tools can also be used to form rounded edges.

All specifications are considered as guidelines and may be subject to changes at any time.



## PowerPackage folding beam

The „power package“ of the PowerBend Universal expands your range of applications. With the reinforced drive and the adjusted folding blade, you effortlessly process up to 4 mm thick sheet steel. To achieve a consistent bending result over the entire working length, it is good to be able to adjust the folding beam. This can be achieved by the optionally available manual or motorized central crowning system.



## You are going into series production?

A motorized back gauge, in the standard version up to 1,000 mm or optionally up to 1,600 mm, is equipped with high-quality recirculated ball screws to achieve an accuracy of  $\pm 0.1$  mm. This guarantees repeatability in series production. For gauge options from 1,600 mm, the stops are divided into two or more sectors, each of which is pneumatically lowered as required. Sheet support tables with balls make handling easy and gentle on the material. In addition, there is the option of extending the table and back gauge to a J or U-shaped table. The basis here is the 1,600 mm closed table (see p. 11).



## Segmented tools

Thanks to its superior drive technology, the machine can handle the most difficult materials. In order to be able to conveniently produce even complex workpieces, we offer you segmented tools. In combination with the pneumatic tool clamping for the folding beam, these tools open up even more space, and the optionally available hydraulic tool clamping on the clamping beam shortens your setup times.

### Dimensions: PowerBend Universal

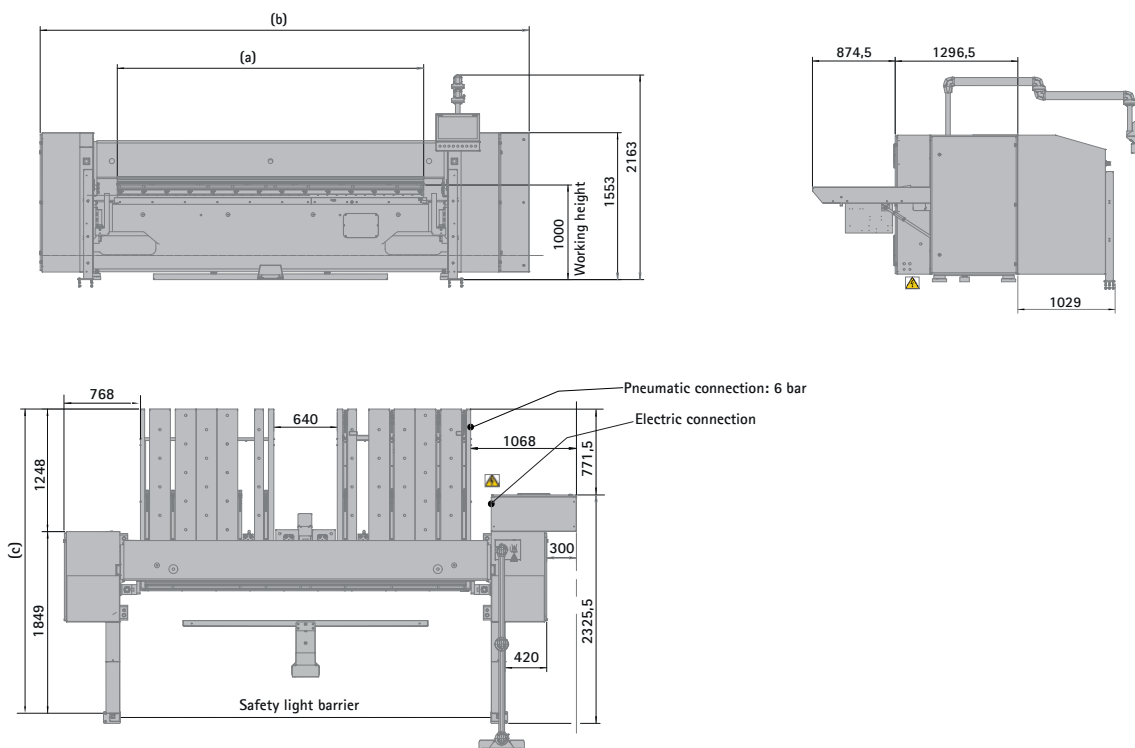

### Options for back gauge extensions

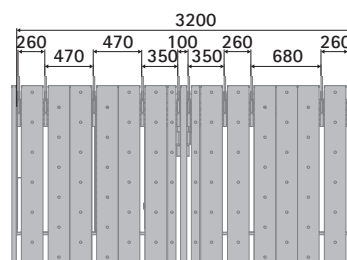
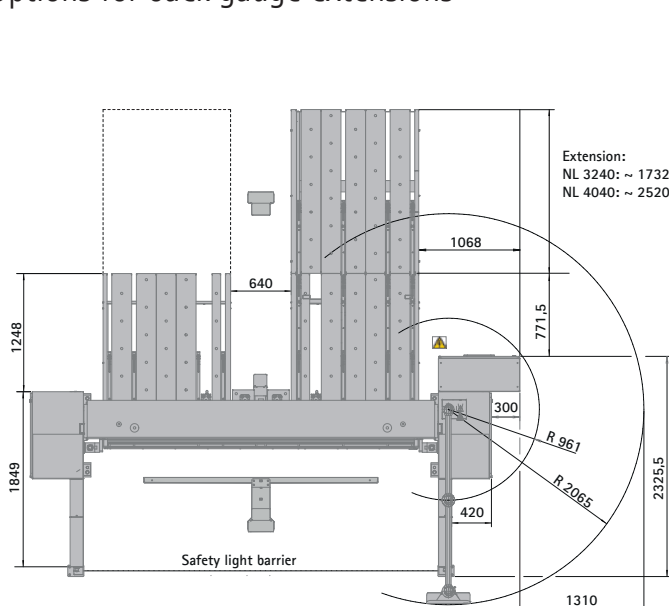

Gauge table 1,600 mm, closed

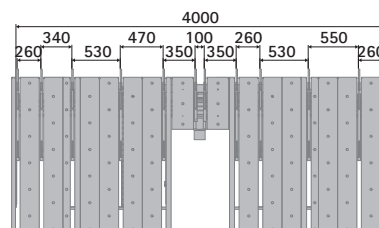

- U shape 1,600, 2 x 800 mm
- U shape 3,200, 4 x 800 mm
- U shape 4,000, 5 x 800 mm

# Folding machine PowerBend Multi

The motorized folding machine PowerBend Multi (PBM) is the successor to our well-known and tested MPB. It is an allrounder for thin sheet metal processing. It's hallmarks: easy and fast handling, high production output and versatile equipment.



PowerBend Multi

Work. length x Sheet thckn. (400 N/mm <sup>2</sup> )	2,520 x 2.5 mm	3,220 x 2.0 mm	4,020 x 2.0 mm
--	----------------	----------------	----------------

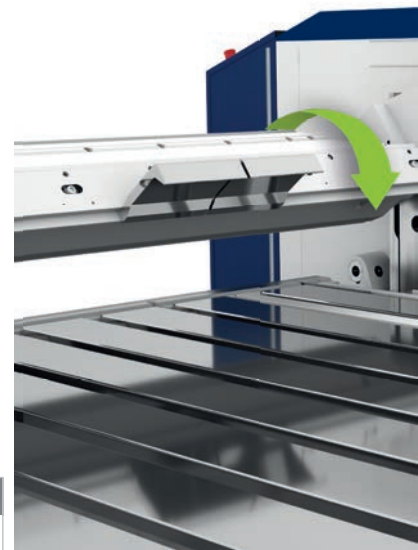

With the rotating clamping beam, the PBM has a second set of up to 170 mm high tools ready.

The PowerBend Multi (PBM) is the new, improved version of the industrial sheet metal folder MPB developed 20 years ago. This machine brings the functional perfection of industrial folding machines to thin sheet metal processing and replaces the reliable allrounder MPB with many new functionalities. PowerBend Multi (PBM) optimally serves the increased requirements especially in the plumbing segment and repair stores.

The precision, performance and speed of this machine reduce unit costs in series production. At the same time, the equipment options and powerful software ensure you all the freedom you need to produce prototypes, one-off orders and small batches.

## Shorter set-up times: the rotating clamping beam

Changing jobs or complex tasks with different folding tools - when equipped with the rotating clamping beam, the PBM always has a second set of tools ready. The rotating clamping beam also has the advantage of a variable clamping beam geometry. This gives you additional freedom for „bulky“ workpieces.



Standard equipment	
Software control	<ul style="list-style-type: none"> <li>- Graphic control POS 2000 Professional on swivelling arm based on Windows 10 operating system</li> <li>- Radius function</li> <li>- All motorized axis converter controlled</li> </ul>
Back gauge	<ul style="list-style-type: none"> <li>- Motorized back gauge 5 - 1,000 mm</li> <li>- Recirculated ball screws (<math>\pm 0,1</math>)</li> <li>- 12 gauge fingers (for 2500 mm or rather 3200 mm)</li> <li>- 14 gauge fingers (for 4000 mm)</li> <li>- Removable sheet support plates, retractable to 337 mm</li> </ul>
Clamping beam	<ul style="list-style-type: none"> <li>- Clamping beam stroke: 160 mm</li> <li>- Drive: 2x 3.0 kW</li> <li>- Recirculated ball screws</li> <li>- Clamping beam geometry: 50°</li> <li>- Tinsmith blade WZS 061, 20°, R 1/1.5 mm, directly screwed to clamping beam, hardened ca. 1100 N/mm<sup>2</sup></li> </ul>
Folding beam	<ul style="list-style-type: none"> <li>- Drive: 2 x 2.2 kW (90°/sec)</li> <li>- Folding beam moved to the back</li> <li>- Manual folding beam adjustment 60 mm</li> <li>- Folding blades cranked 10 mm and 25 mm WZS 130 or rather 131 (from working length 3200 mm: 15 and 25 mm); ca. 700 N/mm<sup>2</sup></li> </ul>
Bottom beam	<ul style="list-style-type: none"> <li>- Bottom beam blade WZS 270, one-piece, ca. 700 N/mm<sup>2</sup>, from 30 mm: 8 mm lowered, with or without finger grooves</li> </ul>
Others	<ul style="list-style-type: none"> <li>- Tool cabinet with shelves</li> <li>- Foot switch</li> </ul>

Special equipment	
Clamping beam	<ul style="list-style-type: none"> <li>- Rotating clamping beam as automatic tool changing system (necessary for goat's foot tools) incl. hydraulic tool clamping (Tool clamping only for goat's foot tools possible)</li> <li>- Hemming function: Folding beam angle increased to 190°</li> <li>- Three stage clamping beam only in combination with option rotating clamping beam and bottom beam without graduation</li> </ul>
Folding beam	<ul style="list-style-type: none"> <li>- Crowning device for folding blade; manual, central crowning (WZS131)</li> <li>- Folding beam adjustment: motorized 60 mm, program-controlled</li> </ul>
Table and back gauge	<ul style="list-style-type: none"> <li>- Back gauge conical bending</li> <li>- Sheet support table with balls</li> <li>- Pneumatically lowerable gauge fingers</li> <li>- back gauge motorized 1600 mm, closed, 2 sectors pneumatically lowerable</li> <li>- U-gauge 1600 mm with 2 gauge sectors (1000/1600 mm) incl. pneumatic lowering device, sheet support table with balls, operation from the rear, 2nd foot switch, access security in front via light barriers + switch and button on panel</li> </ul>
Safety	<ul style="list-style-type: none"> <li>- Additional equipment for 2-man-operation in accordance with accident prevention rules</li> <li>- Customized light barrier package in front, vertically and horizontally</li> <li>- Light barrier aisle side for U-gauge 1600 mm</li> </ul>
Others	<ul style="list-style-type: none"> <li>- Foot switch on rail for lateral movement</li> <li>- Voltage transformer 12 kVA and air conditioner</li> <li>- Options for software control see p. 20f and tool options see p. 26-27</li> </ul>



# Dimensions and technical data



Rear view: 1600 mm back gauge, closed table.

PowerBend Multi	2,500 x 2,5	3,200 x 2,0	4,000 x 2,0
Working length (a)	2,520 mm	3,220 mm	4,020 mm
Sheet thickness (400 N/mm <sup>2</sup> )	2.5 mm	2.0 mm	2.0 mm
Machine length (b)	3,865 mm	4,565 mm	5,365 mm
Machine width with table	2,454 mm		
Machine height (c)	2,109 mm		
Working height (d)	900-1,000 mm		
Machine weight, ca.	5,300 kg	5,950 kg	6,650 kg
<b>Clamping beam</b>			
Stroke	160 mm	160 mm	160 mm
Drive power	2 x 3.0 kW	2 x 3.0 kW	2 x 3.0 kW
<b>Folding beam</b>			
Folding beam adjustment	60 mm	60 mm	60 mm
Drive power	2 x 2.2 kW	2 x 2.2 kW	2 x 2.2 kW
Speed	90°/sec	90°/sec	90°/sec

All specifications are considered as guidelines and may be subject to changes at any time.



## Funktion conical bending

The new PowerBend Multi folding machine is equipped with the conical bending function. This means that pluggable profiles can be produced quickly, easily and with a high degree of precision. Plumbers will appreciate this new feature. Because parapet or wall copings, roof edge trims, verge sheets as well as claddings that have a slope are just a few examples of applications in which parts are required that do not run parallel.



## Small details, big effect

With the PowerBend Multi, the accuracy of workpiece guidance is ensured via pneumatically lowerable gauge fingers and optional gauge sectors. The rotating clamping beam offers you an alternative machine geometry with new clearances. The gauge table also makes room for you if required: Removable sheet support plates (retractable to 337 mm) create space for counterbends.



## Manual central crowning device and folding beam lowering

In order to achieve a consistent bending result over the entire working length, it is important to be able to adjust the folding beam. You can achieve this with the optionally available central crowning, which can be quickly adjusted in just one step. It is also possible to switch between different sheet thicknesses without manual intervention. And thanks to the trouble-free adjustment of the folding beam (optionally motorized), processing times can also be shortened.



## Set-back folding beam and clamping beam

The set-back folding beam with the cranked folding blade opens up new possibilities such as the folding of top-hat or standing seam profiles. In combination with the option of the rotating clamping beam, it is possible to set back the clamping beam and clamp the sheet. This makes it possible to fold hems in only one working step. The biggest advantage here is the high stability during folding compared to the traditional squeezing with the clamping beam.

## Dimensions: PowerBend Multi

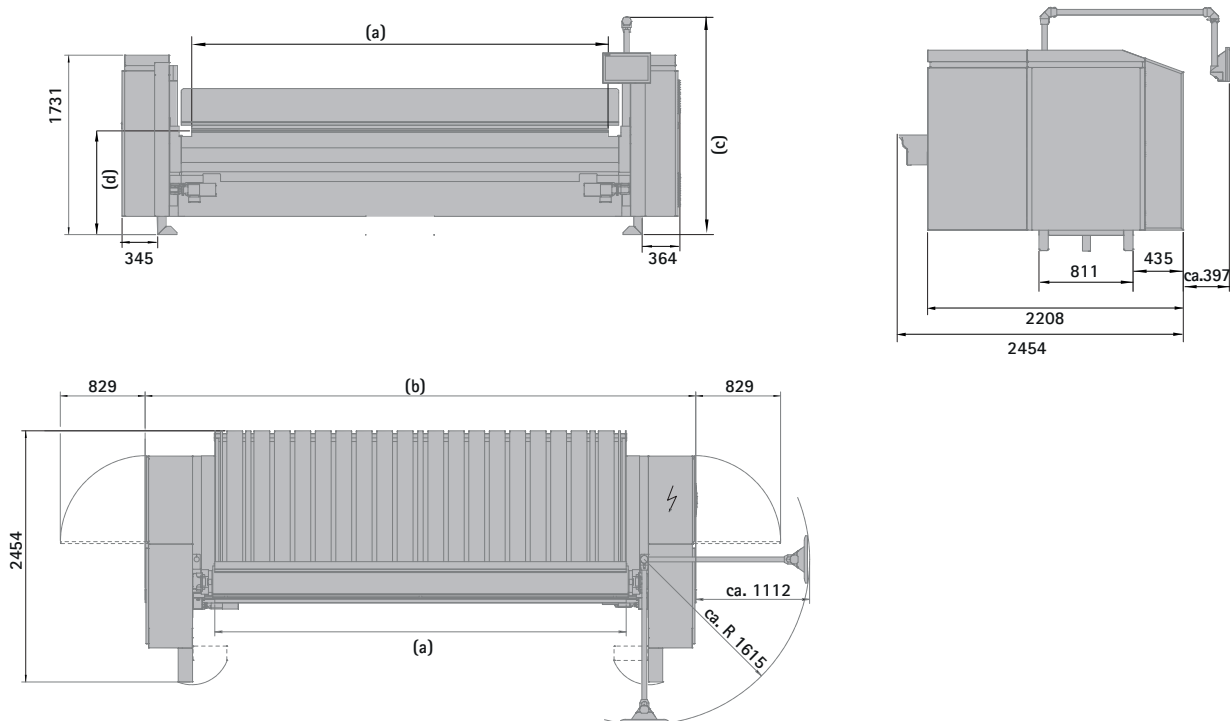

## Options for back gauge extensions

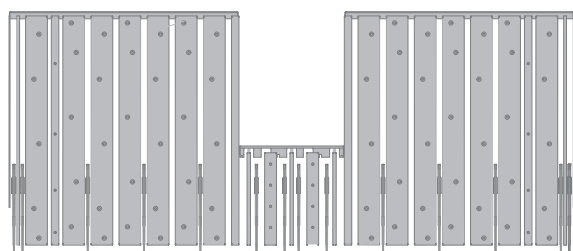

U-shape 1,600, 2 x 800 mm

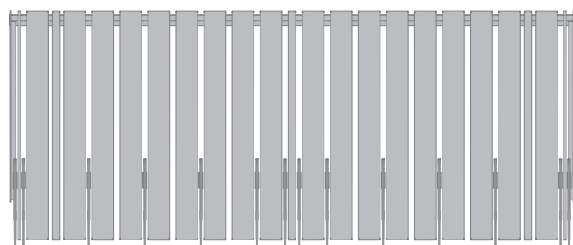

Closed table 1,600 mm

# Folding machine MAKU

The versatile motorized folding machine of the MAK-series is perfect for sheet metal processing in small- and medium-sized workshops.



MAKU

Work. length x Sheet thicken. (400 N/mm <sup>2</sup> )	2,020 x 2.5 mm	2,520 x 2.0 mm	3,220 x 1.5 mm
--	----------------	----------------	----------------

In the standard version the MAKU is equipped with the new Classic Bend control - this makes it an extremely versatile machine.



Crowning device for folding beam: manual central crowning device (not in combination with cranked folding blades).

The motorized folding machine MAKU of the MAK-series convinces with its robust and stable construction. The „U“ in its name was intentionally made and stands for „Universal“: this folding machine is designed to meet the demands of sophisticated handicraft businesses. Its flexibility through applications up to 2.5 mm steel is the result of Hans Schröder Maschinenbau's decades of experience in industrial sheet metal folding. The MAKU offers optimum precision, longevity and stability. It was engineered using extremely rigid machine bodies according to state-of-the-art technology.

This versatile machine is a safe investment into motorized sheet metal processing - and in the future of your company.

With the MAKU you get the know-how from our industrial machines for your workshop. Folding machines from Schröder are extremely long-lasting, low-maintenance and aimed at continuous operation with same high quality. You are able to produce faster and to reduce unit costs. You can not only increase your competitiveness through quick small series production but also thanks to sophisticated single orders in the short-term and with utmost precision.

The path-breaking electronic software control, that already masters radius bending in its standard, can be programmed quickly with no computer skills. Anyone can program with the Classic Bend, making it the perfect machine for a wide array of production requirements. The MAKU is the motorized folding machine for increased efficiency in your production.

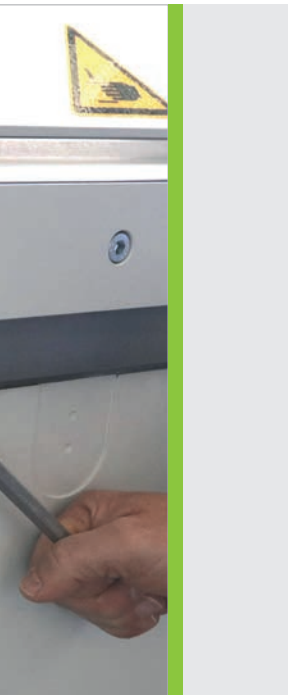

Standard equipment	
Software control	<ul style="list-style-type: none"> <li>- Positioning control Classic Bend, touchscreen monitor turnable on switch cabinet</li> <li>- Radius function</li> </ul>
Clamping beam	<ul style="list-style-type: none"> <li>- 45° clamping beam with clearance 65 mm</li> <li>- Drive: middle motor 0,75 kW (converter-controlled, eccentric drive)</li> <li>- Clamping beam stroke: 150 mm</li> <li>- Clamping pressure adjustment via handwheel (without tool)</li> <li>- Tinsmith blade 20° (WZS 080) , R 1/1.5 ca. 700 N/mm<sup>2</sup>, clearance 12 mm for hems, foot width 24 mm; optionally sharp-nose blade 20°, foot width 36 mm, directly screwed to clamping beam</li> </ul>
Folding beam	<ul style="list-style-type: none"> <li>- Drive: 1.5 kW (converter-controlled)</li> <li>- Manual folding beam adjustment: 30 mm</li> <li>- Folding blades (WZS 100) 10 mm and 25 mm (from working length 3200 mm: 15 and 25 mm); ca. 700 N/mm<sup>2</sup></li> </ul>
Bottom beam	<ul style="list-style-type: none"> <li>- Bottom beam blade (WZS 270), one-piece, ca. 700 N/mm<sup>2</sup>, from 30 mm: 8 mm lowered depending on chosen gauge</li> <li>- without finger grooves</li> <li>- with finger grooves 6 mm or optionally 10 mm</li> </ul>
Others	<ul style="list-style-type: none"> <li>- Foot switch</li> <li>- Anchor plates incl. dowels</li> </ul>

Special equipment																						
Software control	<ul style="list-style-type: none"> <li>- POS 2000 Professional graphic control on swivelling arm</li> </ul>																					
Clamping beam	<ul style="list-style-type: none"> <li>- One-stage clamping beam drive for tool height 130 mm incl. clamping and adapter (clamping rail from standard configuration dropped)</li> </ul>																					
Folding beam	<ul style="list-style-type: none"> <li>- Manual crowning device, central (not in combination with cranked folding blade)</li> </ul>																					
Table and back gauge	<ul style="list-style-type: none"> <li>- Sheet support table 1,000 mm (without gauge), optionally with steel balls in table</li> <li>- Back gauge package: <table border="1" data-bbox="808 1458 1446 1732"> <thead> <tr> <th>Classic Bend</th> <th>POS 2000 Professional</th> <th>POS 2000 Professional incl. conical bending</th> </tr> </thead> <tbody> <tr> <td colspan="3">Back gauge, motor. 6 - 1,000 mm or 10 - 1,000 mm</td> </tr> <tr> <td>10 gauge fingers (with 2000 mm)</td> <td colspan="2">12 gauge fingers</td> </tr> <tr> <td colspan="3">12 gauge fingers (with 2500 mm or rather 3200)</td> </tr> <tr> <td colspan="3">removable sheet support plates; retractable to 265 mm or rather 300 mm</td> </tr> <tr> <td></td> <td>POS 2000 Professional control</td> <td>POS 2000 Professional incl. conical bending</td> </tr> <tr> <td colspan="3">All drives converter-controlled</td> </tr> </tbody> </table> </li> <li>- Back gauge motorized 1,500 mm with 2 gauge sectors incl. pneumatically lowerable gauge fingers</li> <li>- Back gauge with spring fingers (bottom beam blade without finger grooves)</li> <li>- Pneumatic lowerable gauge fingers</li> <li>- Two gauge fingers for conical bending, adjustment range 5 mm</li> <li>- Two additional gauge fingers for conical bending, adjustment range 5 mm; pneumatically lowerable (only in combination with the option pneumatically lowerable gauge finger)</li> </ul>	Classic Bend	POS 2000 Professional	POS 2000 Professional incl. conical bending	Back gauge, motor. 6 - 1,000 mm or 10 - 1,000 mm			10 gauge fingers (with 2000 mm)	12 gauge fingers		12 gauge fingers (with 2500 mm or rather 3200)			removable sheet support plates; retractable to 265 mm or rather 300 mm				POS 2000 Professional control	POS 2000 Professional incl. conical bending	All drives converter-controlled		
Classic Bend	POS 2000 Professional	POS 2000 Professional incl. conical bending																				
Back gauge, motor. 6 - 1,000 mm or 10 - 1,000 mm																						
10 gauge fingers (with 2000 mm)	12 gauge fingers																					
12 gauge fingers (with 2500 mm or rather 3200)																						
removable sheet support plates; retractable to 265 mm or rather 300 mm																						
	POS 2000 Professional control	POS 2000 Professional incl. conical bending																				
All drives converter-controlled																						
Safety and Others	<ul style="list-style-type: none"> <li>- Additional equipment for 2-man-operation in accordance with accident prevention rules</li> <li>- Foot switch on rail for lateral movement</li> <li>- Cutting device for max. sheet thickness 0.8 mm and guide rail</li> <li>- Tool options see p. 26</li> </ul>																					

# Dimensions and technical data



MAKU	2,000 x 2.5	2,500 x 2.0	3,200 x 1.5
Working length (a)	2,020 mm	2,520 mm	3,220 mm
Sheet thickness (400 N/mm <sup>2</sup> )	2.5 mm	2.0 mm	1.5 mm
Machine length (b)	3,275 mm	3,775 mm	4,475 mm
Length of working area (c)	2,420 mm	2,920 mm	3,620 mm
Machine height (d)	1,255 mm		
Working height (e)	870 mm		
Weight	2,150 kg	2,400 kg	2,700 kg
<b>Machine width</b>			
Without gauge	995 mm		
Sheet support table 1,000 mm	1,970 mm		
Back gauge, motorized 1,000 mm resp. 1,500 mm (f)	1,970 mm		
<b>Clamping beam</b>			
Stroke	150 mm		
Drive power	0.75 kW		
Speed	65 mm/sec (85 mm/sec)		
<b>Folding beam</b>			
Adjustment	30 mm		
Drive power	1.5 kW		
Speed	65°/sec (90°/sec)		
<b>Back gauge</b>			
Speed	300 mm/sec		

Thanks to the set back folding beam with a cranked folding blade trapezoidal sheets and profiles with standing seams are very easy to bend.

All specifications are considered as guidelines and may be subject to changes at any time.



## Various table and back gauge options

We offer you back gauges and different sheet support table options that are perfect for your requirements. The support plates of the back gauge table can be retracted easily by hand. Thus you create more space. Optionally the back gauge table can be equipped with steel balls in order to position the sheet more smoothly. Furthermore, you are able to extend the back gauge with spring fingers. In order to turn the sheet on the table more comfortably we offer you the possibility to lower the back gauge fingers pneumatically.

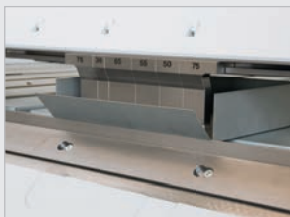

## Practical tools and recessed folding beam

The tool system WZS 010 for the MAKU can be acquired optionally and has already been used for many Schröder machines for a long time. The segmented goat's foot tools enable bending up to 110 mm high boxes. Likewise, a set back folding beam with a cranked folding blade enables new possibilities such as the bending of top-hat and standing seam profiles or trapezoidal sheets.



## Conical bending

The MAKU is also available with a 2 axis back gauge. No matter whether you want to bend parallel or conical! We develop solutions to facilitate your work. So get your MAKU and break new grounds!



Dimensions: MAKU with Classic Bend control

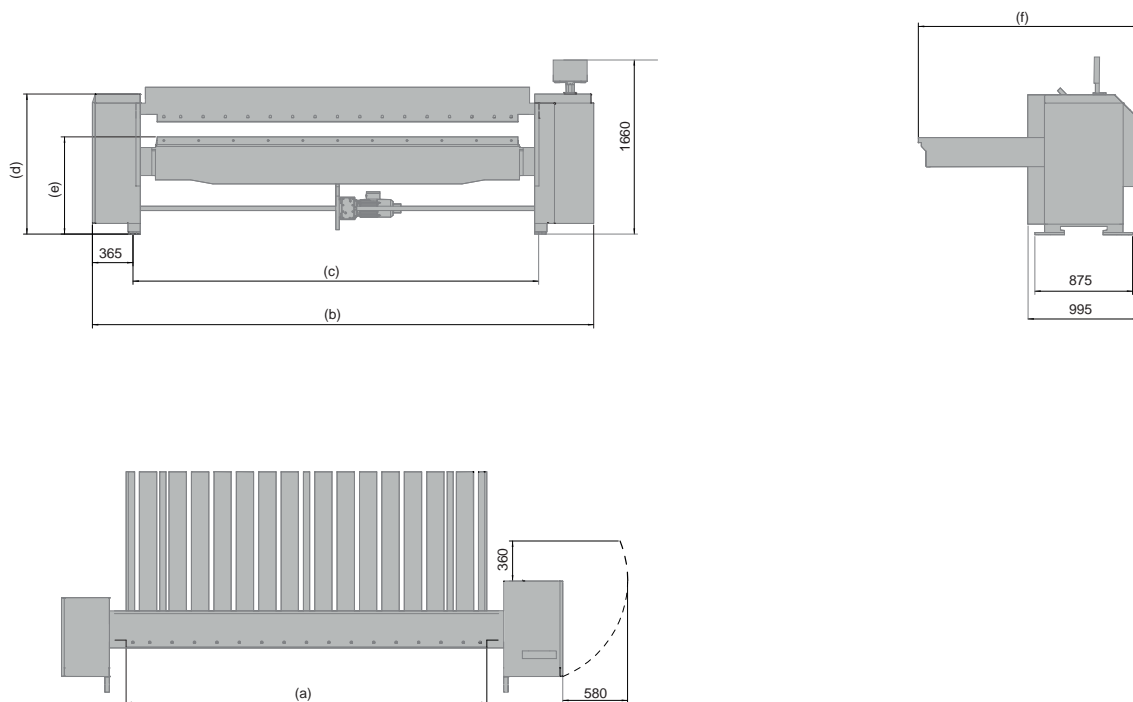

Dimensions: MAKU with POS 2000 Professional control

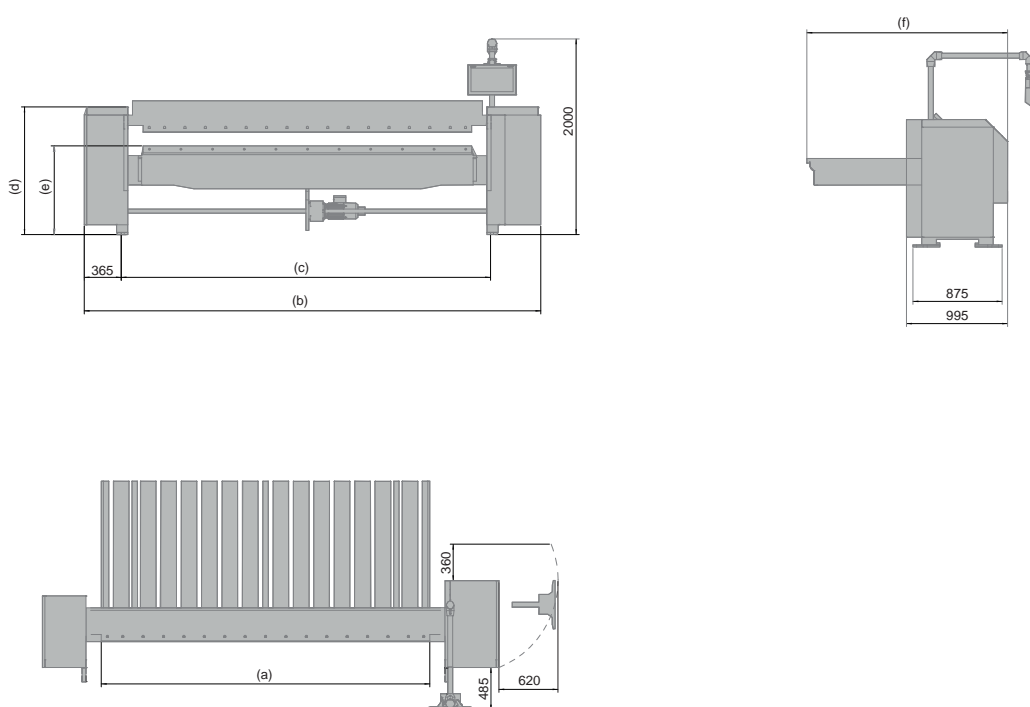

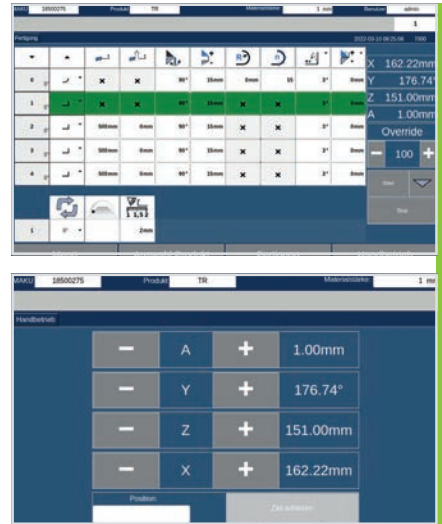

Simple symbols and alphanumeric data describes the bending program.

## Classic Bend – the most clearly laid-out alphanumeric control

We developed the modern Classic Bend alphanumeric control as the standard software for craftsmen and industrial manufacturers who use folding machines like MAKU and PowerBend Universal.

Classic Bend controls the clamping beam and the folding beam using a path measurement system, and the motorized back stop is controlled via the digitally controlled frequency inverter. The user interface is clearly laid-out and combines easy-to-understand icons with text and numerical displays.

Do you need unified bending programs for metal sheets of different quality? Special programs no longer need to be created in case of material-dependent deviations when using Classic Bend. The option to enter corrections to settings for the clamping beam and the folding beam is available for each bend.



### Highlights

- Bending programs are stored in folder structures
- Icon based programming
- Possibility of incremental step programming
- Position measurement system
- Separate axis correction for each step
- Bending list with current bend highlighted
- Scribe bending
- Piece counter
- Foot pedal display

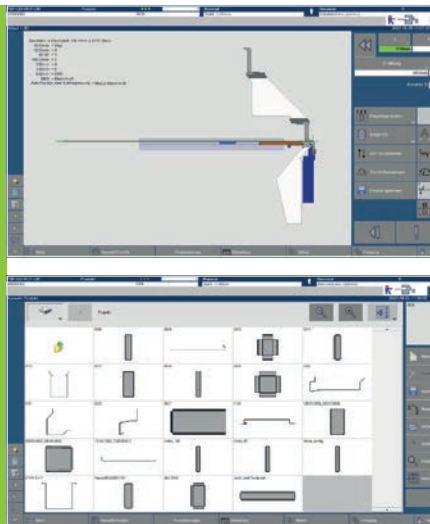

Above: Standard bending programs are available in the product selection menu.  
Below: The software shows the processing steps beforehand.



## POS 2000 Professional – the standard for industrial folding machines

The POS 2000 Professional software qualifies as the direct successor of the POS 2000, THE controller for folding machines, which has been proved and expanded in hundreds of installations across the world.

Work quickly and precisely with this software. Support and guidance through the software reduces the number of errors and error costs resulting during sheet processing to the minimum.

A comprehensive, expandable catalogue enables the desired program components to be selected in POS 2000 Professional. The angle and side dimensions are easily changed by pressing the monitor. The cut length is displayed depending on the material and geometry involved.

The software control displays exactly what the machine is doing: The folding machine, work piece, and tool are displayed schematically and updated for every bending step. Anyone who programs preparation of the work away from the machine can test the quality of their program using the bending simulation, which effectively avoids waste and delays during production. This is what makes our control software so uniquely user-friendly: all of the necessary operator activities like turning, rotating, etc. are displayed for each bending step.



### Highlights

- PC touchscreen control on swivelling arm
- Windows operating system
- Extensive profile catalog, unlimited expansion possible
- Automatic cut calculation
- Material and tool library
- True-to-size bending simulation
- Zoom function
- Speed of the CNC axis infinitely variable
- Radius function

### Options

- External programming (POS 2000 Professional PC-Version)
- Remote maintenance



A man-machine-interface as it should be:  
Touchdisplay panels are used to give instructions to Schröder folding machines.



Above: The control software becomes a convenient product catalog.  
Below: Not only the work piece is displayed, the tools are also shown – in this case, in the mounting plan.

## POS 3000 3D graphic control: Interactive sheet design

With the POS 3000 3D graphic control, our sheet folding specialists are setting new standards in the control of industrial sheet metal processing.

The high-end POS 3000 control and the folding machines in the Evolution series from Schröder are a perfect match, including control over complex machine options like automatic tool changers and handling robots.

Special feature: Program graphically with the POS 3000. Since ultimately, we know that: Your operating staff and preparation employees have a better eye for products than they do for IT programming lines. The machine, tool, work piece, and type

of bend are all clearly displayed. That's why your employees bend visually on the screen beforehand and check the result in the software's 3D bending simulator, making sure that the sheet metal will be processed perfectly from the first bend. Bending programs that have already been created can be called up again quickly, checked visually, and corrected according to material requirements.

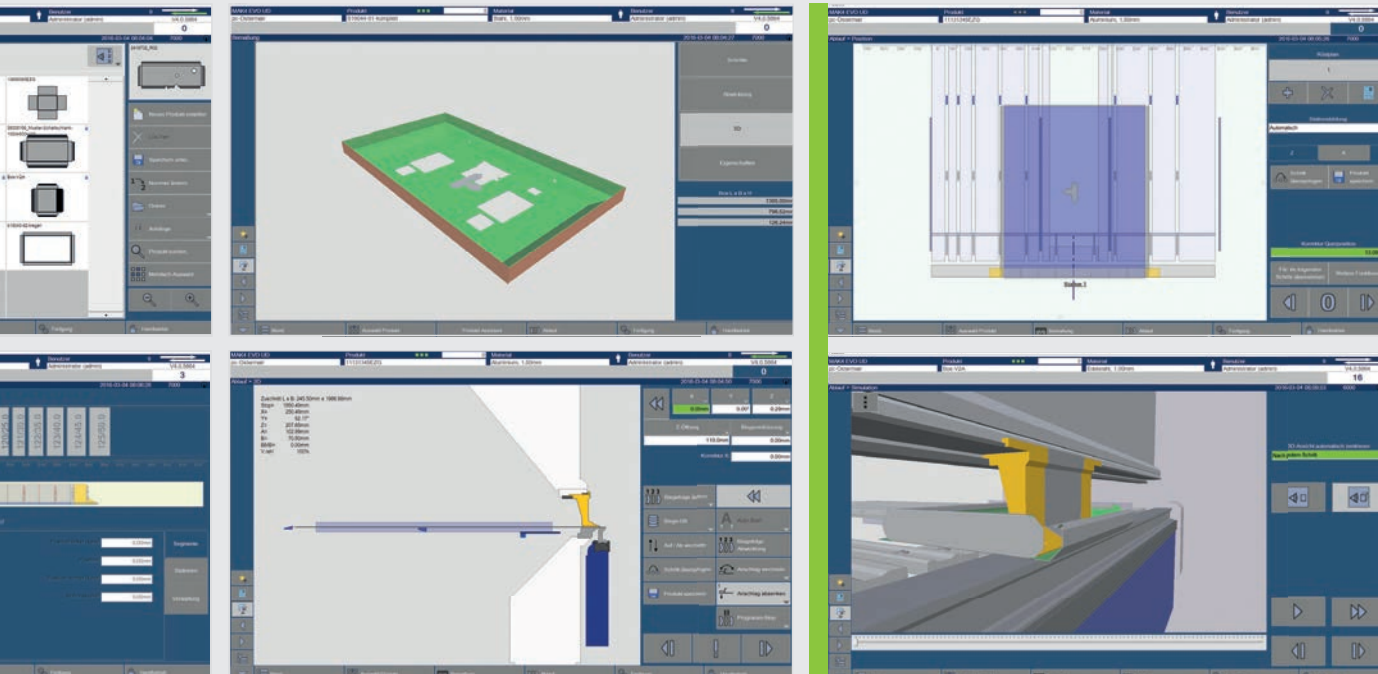

Above: the 3D display simplifies dimensioning.  
Below: a 2D display of the bending position.

Above: the position of the sheet on the back stop is displayed in the programming plan.  
Below: POS 3000 simulates production in 3D.

## Working with POS 3000 is extremely comfortable:

Clearly laid-out product selection including a search function and navigation in submenus enables the operator to select work steps and connect them in the production plan menu to create sequences.

Individual product profiles can be designed very quickly via the intuitive finger-activated drawing feature. The exact dimensions may be entered and changed in the dimensioning menu. In order to check and coordinate together with the customer, the drawing may be output on paper using a printer.

Using the program that is created, the software generates the optimal sequence of bends, including automatic collision and threshold value monitoring. The folding angle and cut are corrected automatically using interpolation from the database.



## Highlights

- 3D-graphic control incl. schematic depiction of the machine, tools and work piece
- Intuitive, visusal touchscreen-programming
- 3D-bending simulator for visual program inspection
- Cycle time calculator
- Radius function
- Remote maintenance
- CAM-connection
- ERP/PPS-interface / DXF, BPX and Geo-import
- Prepared interface to product handling systems
- Industry 4.0 ready through OPC UA

## Options

- External programming (POS 3000 PC-Version)
- Unfold software „SCHRÖDER Unfold“



# Tools

## Bottom beam tools

## Folding beam tools

### PowerBend Professional

#### Standard

*Bottom beam tools WZS 16300*

ca. 1100 N/mm<sup>2</sup> surface-hardened (nitrated)

- Bottom beam blade one-piece with finger grooves, minimum gauge 10 mm
- Up and Down Bottom beam blade one-piece ca. 1100 N/mm<sup>2</sup>; 30°, R 1/1.5/3 with finger grooves, minimum gauge 10 mm

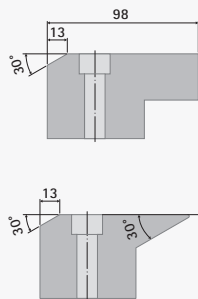

#### Option

*Bottom beam tools WZS 16400*

ca. 1100 N/mm<sup>2</sup> surface-hardened (nitrated)

- Bottom beam blade divided H = 55 mm, clearance 34 mm with finger grooves, minimum gauge 10 mm (not in combination with Up-and-Down-function)

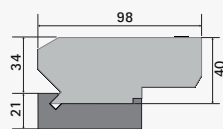

#### Option

*Folding beam tools WZS 15100*

pneumatic clamping, ca. 1100 N/mm<sup>2</sup>, surface-treated (phosphated)

- Folding blades segmented 10/15/20/25 mm, 108 mm high

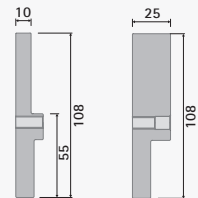

### PowerBend Universal

#### Standard

*Bottom beam tools WZS 16300*

ca. 1100 N/mm<sup>2</sup> surface-hardened (nitrated)

- Bottom beam blade one-piece with finger grooves, minimum gauge 10 mm

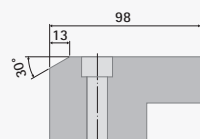

#### Option

*Bottom beam tools WZS 16400*

ca. 1100 N/mm<sup>2</sup> surface-hardened (nitrated)

- Bottom beam blade divided H = 55 mm, clearance 34 mm with finger grooves, minimum gauge 10 mm

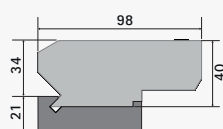

#### Option

*Folding beam tools WZS 15000* (only with manual clamping)

ca. 1100 N/mm<sup>2</sup>, surface-treated (phosphated)

- Folding blade one-piece 98 mm high directly screwed, 10/15/20/25/35 mm

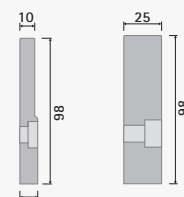

*Folding beam tools WZS 15100*

ca. 1100 N/mm<sup>2</sup>, surface-treated (phosphated)

- Folding blades segmented 108 mm high 10/15/20/25/35 mm

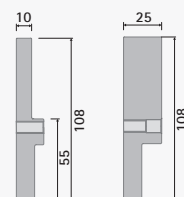

## Clamping beam tools

## Additional tools

## Option

*Clamping beam tools WZS 2000*  
hydraulic clamping, ca. 1100 N/mm<sup>2</sup> surface-treated  
(phosphated)

- Sharp nose blade  
30°, R 1/1.5/3,  
divided

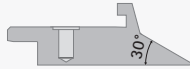

- Tinsmith blade  
20°/30°, R 1/1.5/3,  
clearance on the rear 8 mm,  
foot width 20 mm, divided

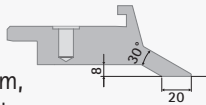

- Goat's foot blade  
120 mm, 170 mm or  
250 mm high,  
20°/30°, R 1/1.5/3,  
clearance 45 mm  
foot width 85 mm

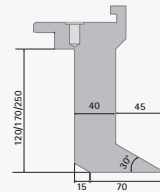

- Goat's foot blade  
120 mm/170 mm high,  
20°/30°,  
R 1/1.5/3,  
clearance 30 mm  
foot width 50 mm

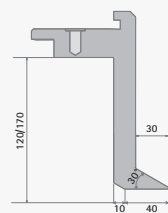

Example segmentation of folding blades at a working length of 3,240 mm – other working lengths are each filled with 200 segments

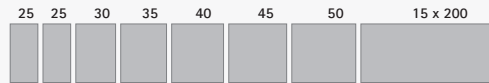

Example segmentation of goat's foot blades at a working length of 3,240 mm – other working lengths are each filled with 200 segments



Additional pair of hinged corner parts (2 x 110 mm)

## Option

*Clamping beam tools WZS 2000*  
as PowerBend Professional up to max. goat's foot height 170 mm

*Clamping beam tools WZS 020*  
manual clamping, hardened, ca. 1100 N/mm<sup>2</sup>

- Sharp nose blade  
30°, R 1/1.5/3, divided

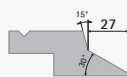

- Tinsmith blade  
30°, R 1/1.5/3,  
clearance on the rear 10 mm,  
foot width 20 mm,  
divided, s = 2 mm

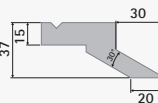

- Goat's foot blade  
100 oder 140 mm high,  
(total height 130 mm or  
rather 170 mm),  
30°, R 1/1.5/3,  
clearance 30 mm,  
foot width 50 mm

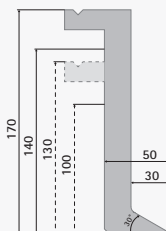

Example segmentation of folding blades at a working length of 2,040 mm – other working lengths are each filled with 200 segments



Example segmentation of goat's foot blades at a working length of 2,040 mm – other working lengths are each filled with 200 segments

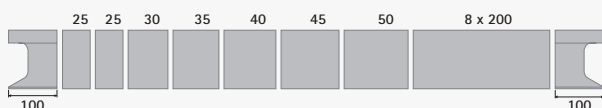

Additional pair of hinged corner parts (2 x 110 mm)  
(only with WZS 2000)

# Tools

## Bottom beam tools      Folding beam tools

### PowerBend Multi

#### Standard

Bottom beam tools WZS 270  
ca. 700 N/mm<sup>2</sup>

- Bottom beam blade one-piece from 30 mm: 8 mm lowered
- with finger grooves
- without finger grooves

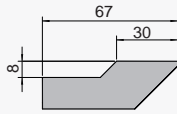

#### Option

Bottom beam tools WZS 270

- Bottom beam blade without gradation, with finger grooves
- Bottom beam blade without gradation, without finger grooves

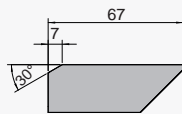

#### Standard

Folding beam tools WZS 130 bzw. 131  
ca. 700 N/mm<sup>2</sup>

- Folding beam moved to the back incl. folding blades cranked 10 and 25 mm (from work. length 3200 mm: 15 and 25 mm)

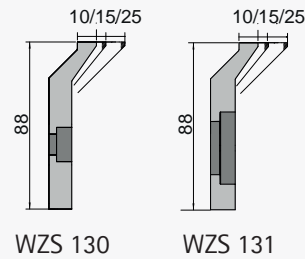

### MAKU

#### Standard

Bottom beam tools WZS 270  
one-piece, ca. 700 N/mm<sup>2</sup>

- Bottom beam blade one-piece from 30 mm: 8 mm lowered
- without finger grooves
- with finger grooves 6 mm or optionally 10 mm

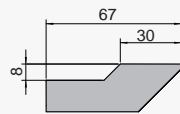

#### Option

Bottom beam tools WZS 270

- Bottom beam blade one-piece without gradation
- without finger grooves
- with finger grooves

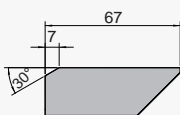

#### Standard

Folding beam tools WZS 100  
ca. 700 N/mm<sup>2</sup>

- Folding blade one-piece directly screwed, 10 and 25 mm, 68 mm high (from work. length 3200 mm: 15 and 25 mm)

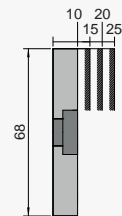

#### Option

With folding beam moved to the back:  
Folding beam tools WZS 130  
ca. 700 N/mm<sup>2</sup>

- Folding blades cranked 10 and 25 mm (from work. length 3200 mm: 15 and 25 mm)  
Not in combination with crowning device, folding blades from standard configuration are dropped

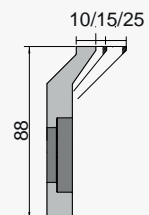

## Clamping beam tools

## Additional tools

### Standard

Clamping beam tools WZS 061  
hardened ca. 1100 N/mm<sup>2</sup>

- Tinsmith blade directly screwed  
20°, R 1/1.5,  
clearance on the rear 8 mm,  
clearance 27 mm,  
foot width 30 mm

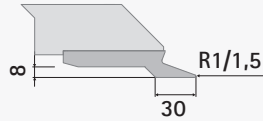

### Option

Clamping beam tools WZS 010 (Only in combination with rotating clamping beam) hardened ca. 1100 N/mm<sup>2</sup>

- Goat's foot blade  
130 or 170 mm high,  
30°, R1/1.5  
clearance 30 mm,  
foot width 50 mm,  
free space 110 mm/150 mm,  
segmented incl. corner parts

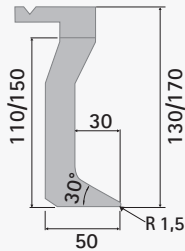

Example segmentation of goat's foot blades at a working length of 2,520 mm.

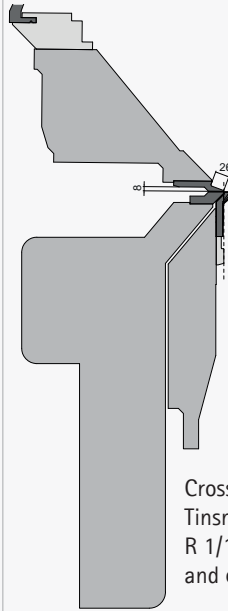

Cross section tool:  
Tinsmith blade 20°,  
R 1/1.5, directly screwed  
and cranked folding blade

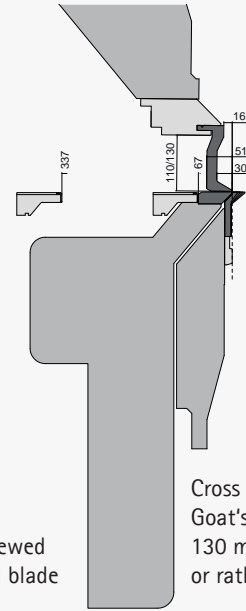

Cross section tool:  
Goat's foot blade:  
130 mm  
or rather 170 mm

### Standard

Clamping beam tools WZS 080  
hardened ca. 700 N/mm<sup>2</sup>, directly screwed

- Tinsmith blade one-piece  
20°, R 1/1.5/3,  
foot width 24 mm,  
clearance 12 mm

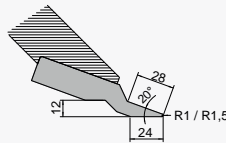

- Sharp nose blade one-piece  
20°, R 1/1.5/3,  
foot width 36 mm

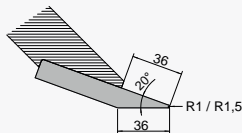

### Option

Clamping beam tools WZS 010 for clamping rail  
hardened ca. 1100 N/mm<sup>2</sup>

- Goat's foot blade  
30°, R1 or R1.5,  
130 mm high,  
clearance 30 mm,  
foot width 50 mm,  
segmented incl. corner parts

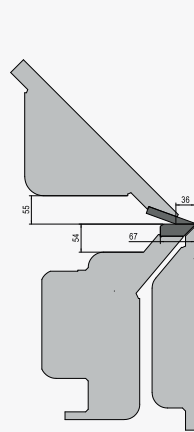
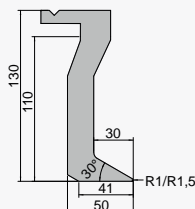

Cross section tool:  
Sharp nose blade,  
directly screwed  
Standard folding blade

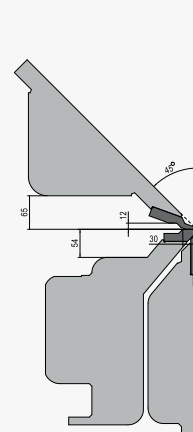

Cross section tool:  
Tinsmith blade,  
directly screwed and  
cranked folding blade

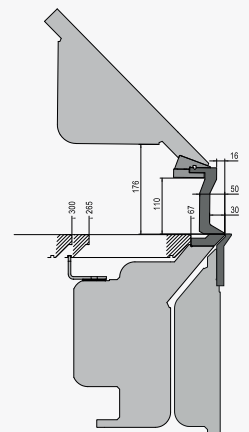

Cross section tool:  
Goat's foot blade: 130 mm  
free space 110 mm

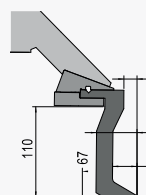

Tool clamping  
for WZS 010



## Schröder Group

The Schröder Group consists of Hans Schröder Maschinenbau GmbH, which is located in Wessobrunn, Germany, SCHRÖDER-FASTI Technologie GmbH, located in Wermelskirchen, Germany and the SMU GmbH, located in Leinburg-Weißenbrunn.

Founded in 1949, Hans Schröder Maschinenbau GmbH unifies traditional and modern approaches in machine building: Successfully managed as a quality and customer-oriented, family-owned company, Hans Schröder Maschinenbau is specialized in the development of modern machine concepts for bending and cutting sheet metal.

The successful integration of the Fasti Company in 2006 and its worldwide presence make the Schröder Group one of today's leading providers of machines for bending, cutting, beading, flanging, and circular bending all types of sheet metal. The company's precision machines range from proven solutions for craftsmen to innovative, high-performance machines for automatic industrial production processes. 2021 the Schröder Group was expanded by the tool manufacturer SMU GmbH. Overall, the Schröder Group currently employs more than 300 people at various locations at home and abroad.

All information provided as a guide only  
and subject to change at all times.  
HSM 231011EN

Hans Schröder Maschinenbau GmbH  
Feuchten 2 | 82405 Wessobrunn-Forst | Germany  
T +49 8809 9220-0 | F +49 8809 9220-700  
E [info@schroedergroup.eu](mailto:info@schroedergroup.eu)  
[www.schroedergroup.eu](http://www.schroedergroup.eu)



Follow us on Instagram:  
[www.instagram.com/schroedergroup/](https://www.instagram.com/schroedergroup/)



Follow us on Facebook:  
[www.facebook.com/schroedermaschinenbau/](https://www.facebook.com/schroedermaschinenbau/)



Follow us on YouTube:  
[www.youtube.com/user/SchroederGroup](https://www.youtube.com/user/SchroederGroup)

**SCHRÖDER**  
GROUP